

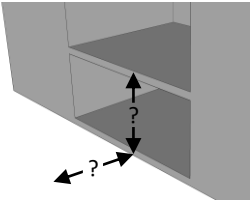

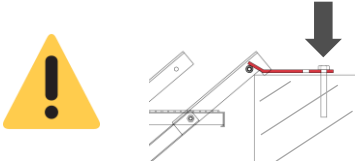

## Työmaaporras 1 m

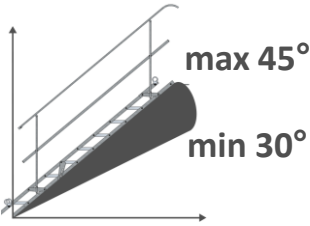

## EN 12811-1:2003

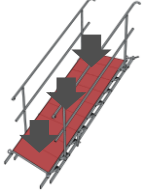
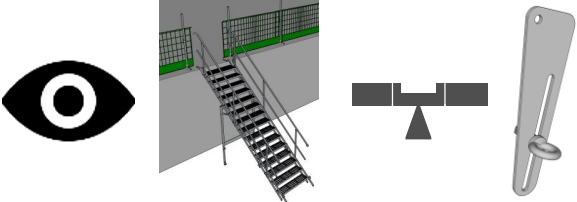
Käytä turvavarusteita!	
Tarkista etäisyys ja korkeus!	
Kiinnitä työmaaporras	
Kaltevuus: min 30° - max 45°	
Pistekuorma: max 150 kg	
Jaettu kuorma: ≤100 kg/m <sup>2</sup>	
Tarkista porraskorkeus silmämääräisesti aina ennen käyttöä	
Poista lika ja lumi	

## Tuotteet

**Työmaaporras 1 m / 3 askelmaa**

**Tuotekoodi: 2079709**

**Paino: 45 kg**



mm

**Työmaaporras 1 m / 6 askelmaa**

**Tuotekoodi: 2079710**

**Paino: 73 kg**

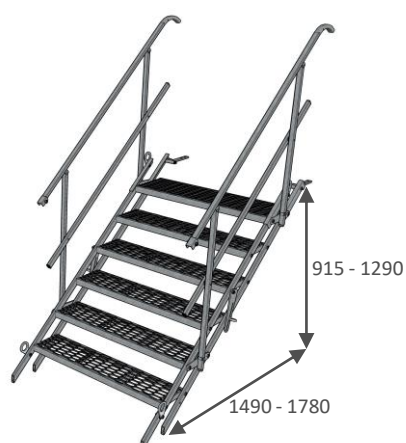

mm

**Työmaaporras 1 m / 9 askelmaa**

**Tuotekoodi: 2079711**

**Paino: 99 kg**

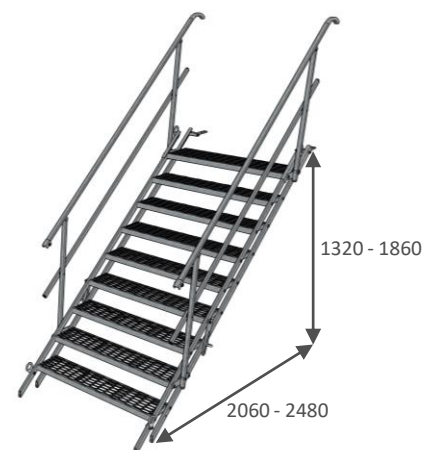

mm

**Työmaaporras 1 m / 12 askelmaa**

**Tuotekoodi: 2079706**

**Paino: 132 kg**

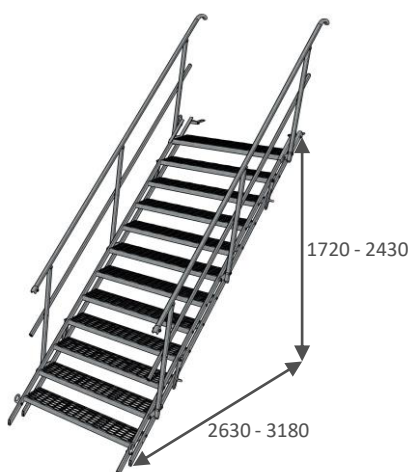

mm

**Työmaaporras 1 m / 15 askelmaa**

**Tuotekoodi: 2079707**

**Paino: 175 kg**

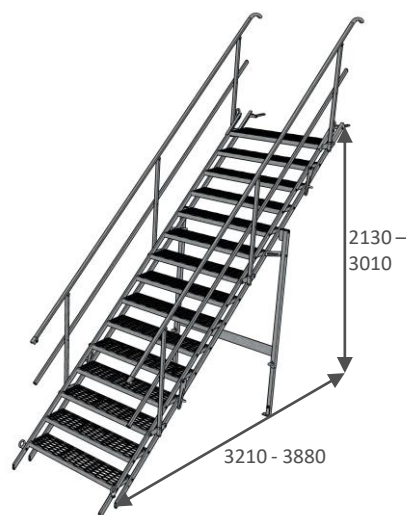

mm

**Työmaaporras 1 m / 18 askelmaa**

**Tuotekoodi: 2079708**

**Paino: 208 kg**

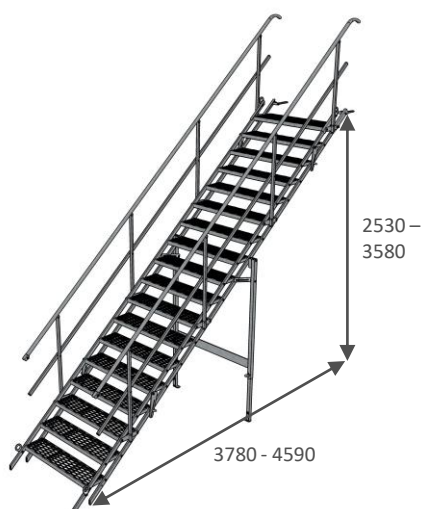

mm

Kokoonpano

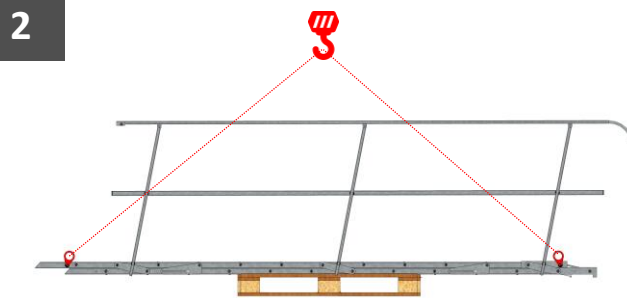
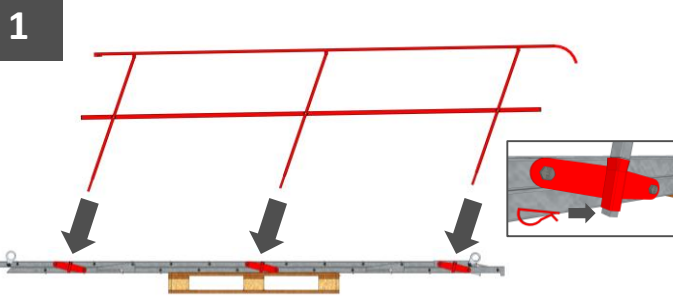

nosturi ≥ 9 askelmaa

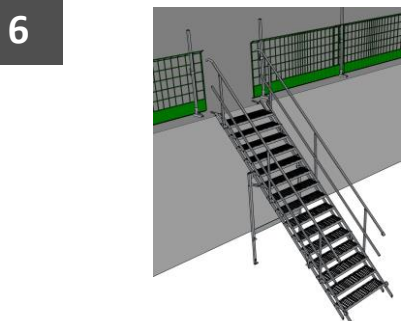
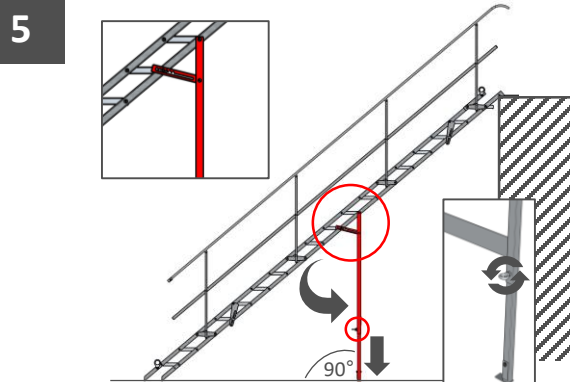
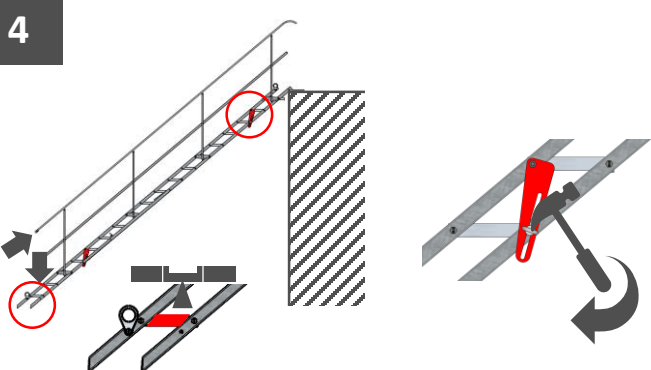
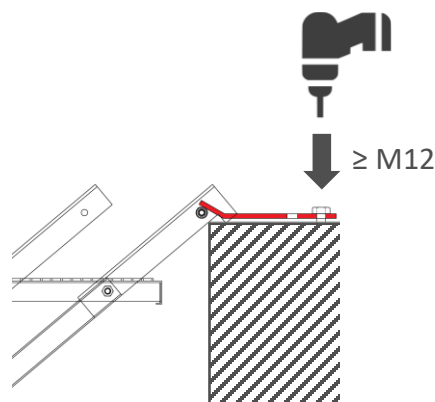
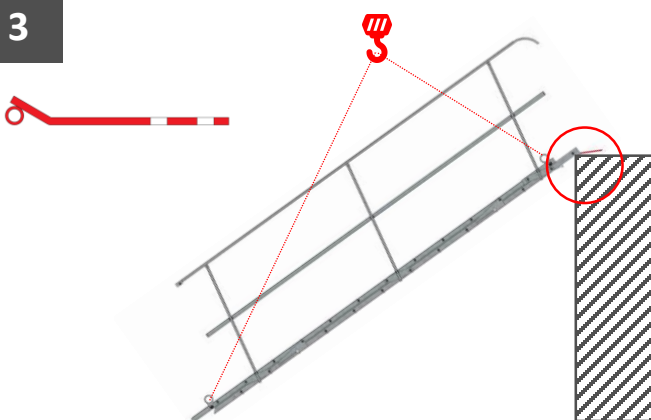

Tarkista joka 7 päivä!



## Portaiden jatkaminen

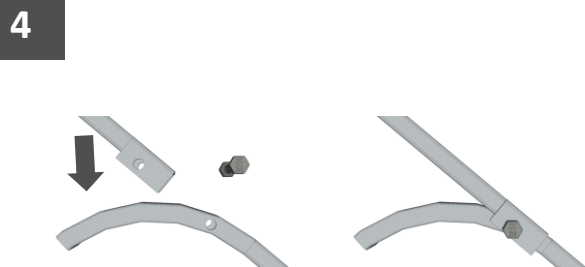
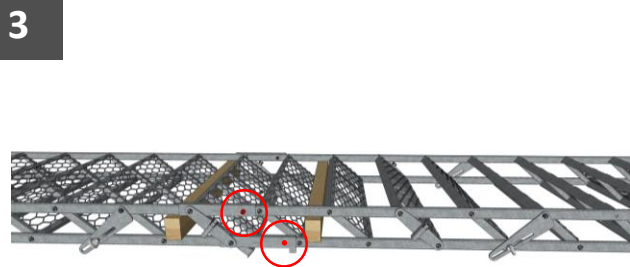
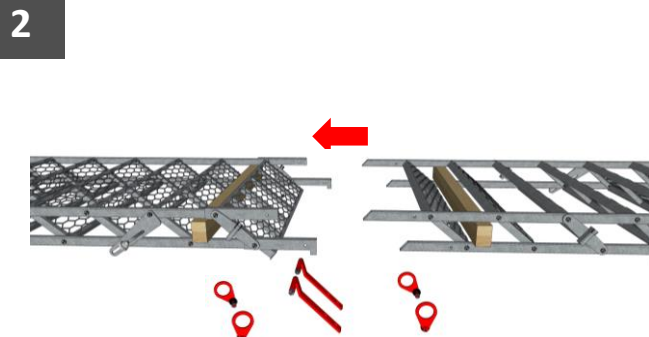
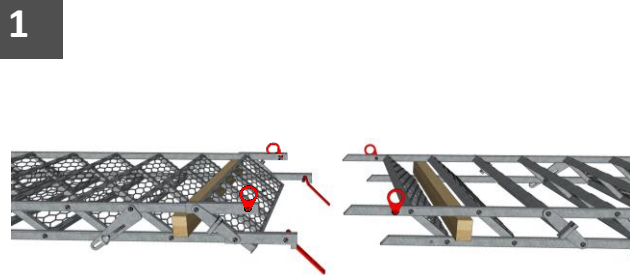

- Max 21 askelmaa (1 välituki vaaditaan)

Korkeus: 3,00 m - 4,70 m

- Maksimissaan 2 porrasta kytkettynä toisiinsa

Esimerkki: 21 askelmaa (18+3)



Porraskaavio

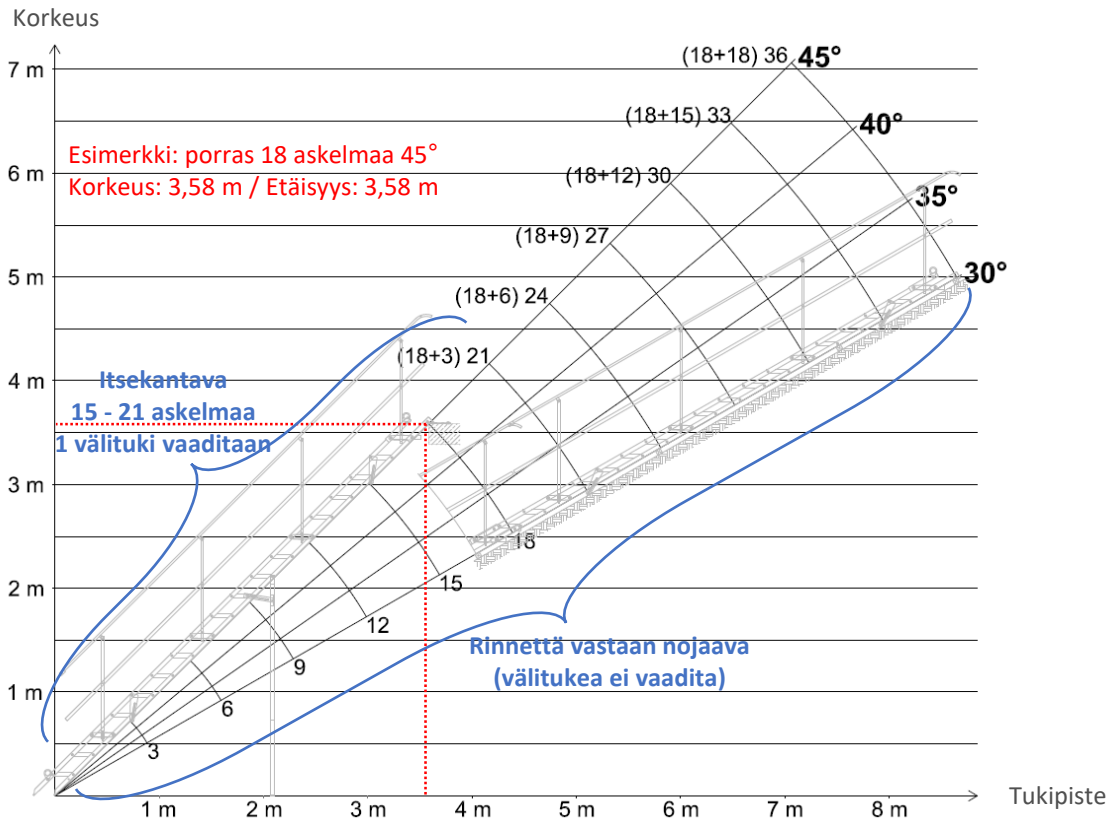

- >21 askelmaa ainoastaan rinnettä vastaan
- >2 korkeintaan porrasta jatkettuna töisiinsa rinnettä vastaan käytettäessä

Pakkaus

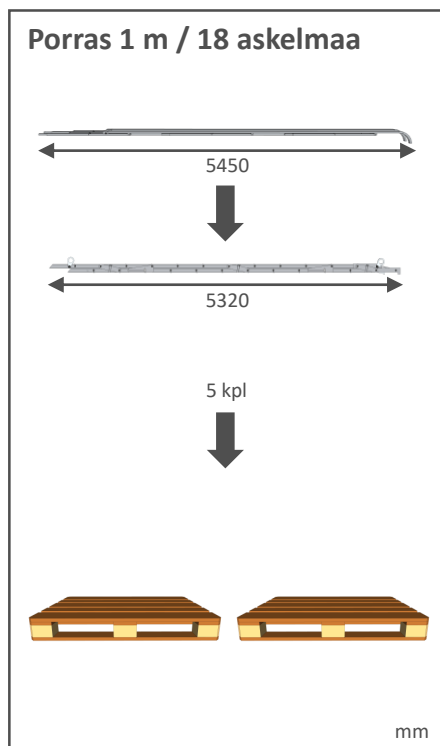
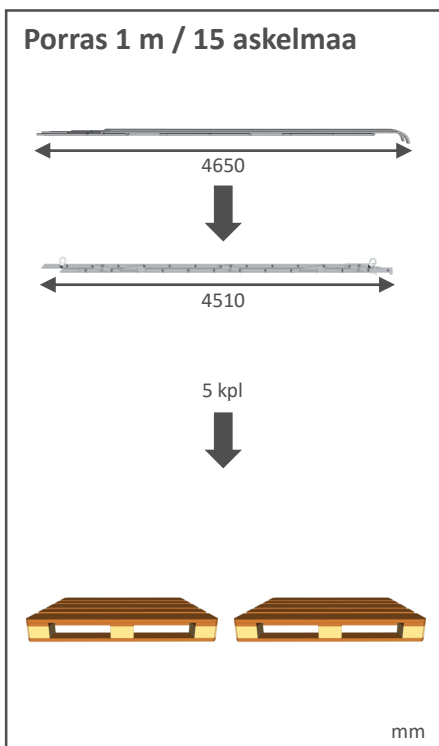
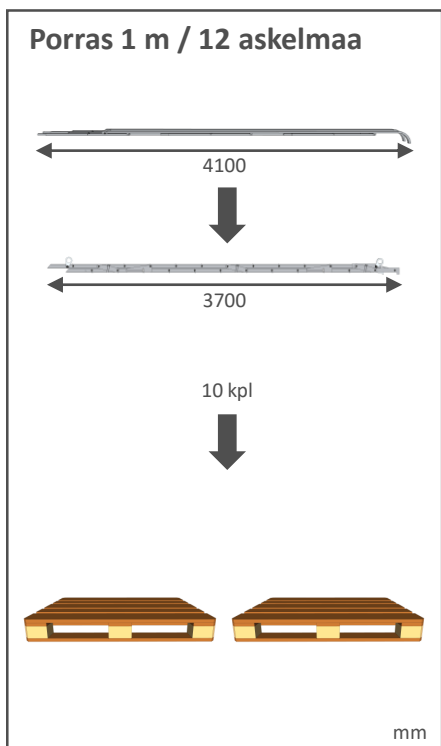
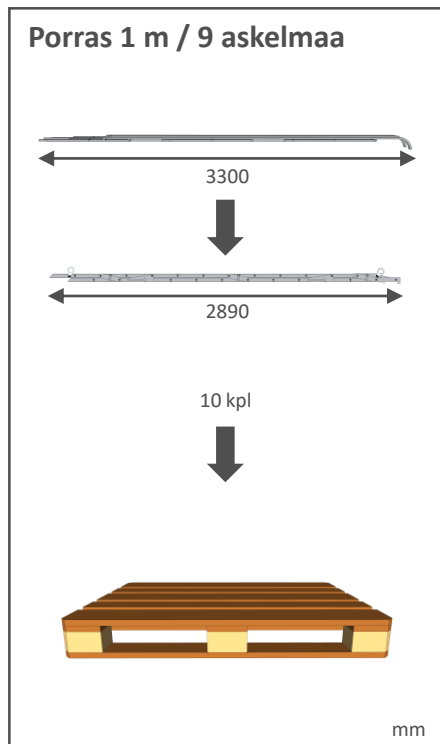
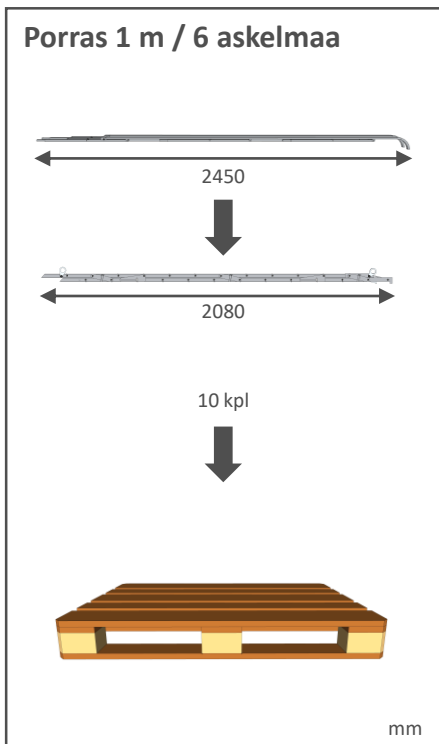
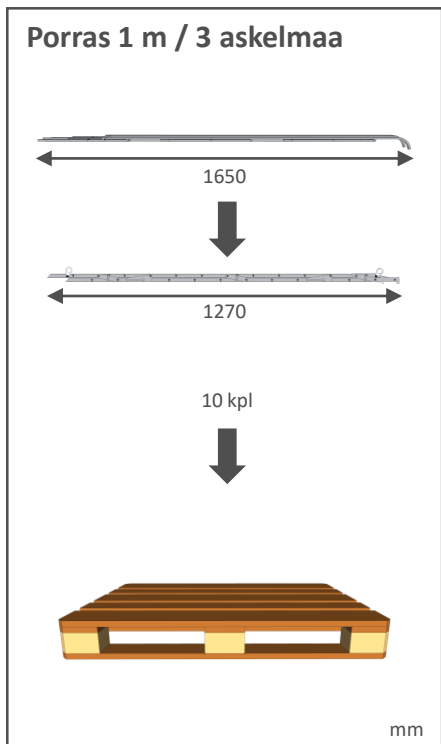

## Työmaaportaiden osat

Esimerkkinä 15-askelman porras

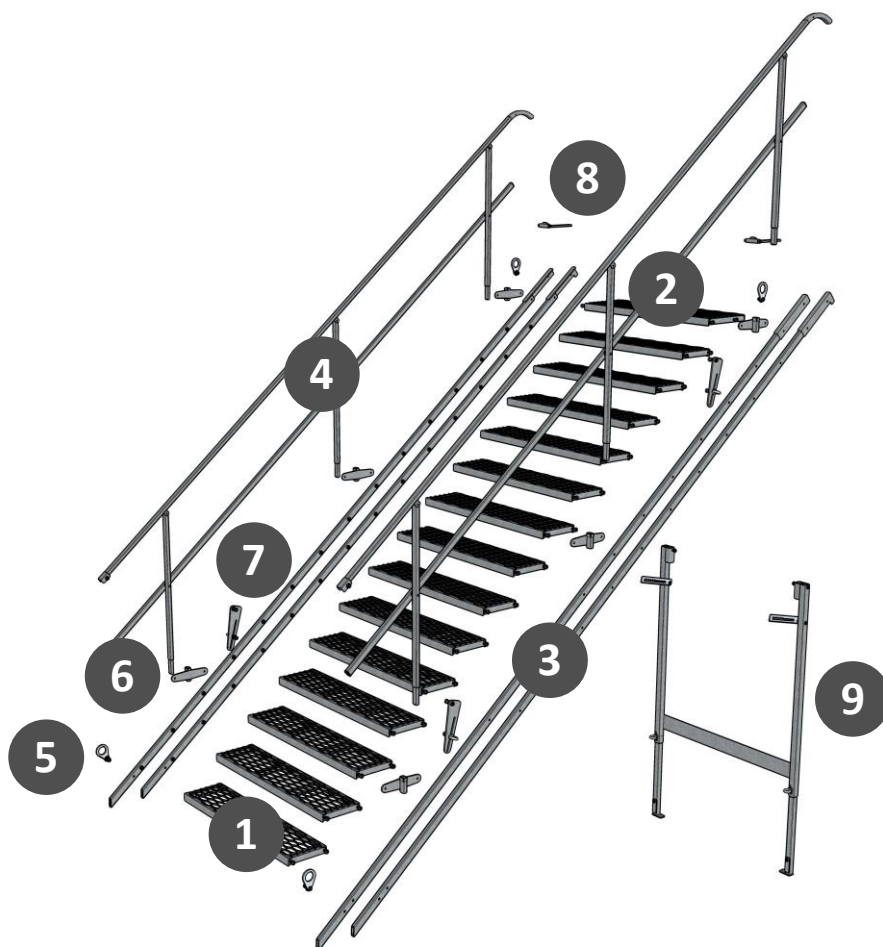

No	Tuotekoodi	Nimi	Kuva
1	2079713	Askelma 1 m standardi	
2	2079714	Askelma 1 m iso	
3	2079707A	Sivupalkki 15 ylä vasen	
	2079707B	Sivupalkki 15 ylä oikea	
	2079707C	Sivupalkki 15 ala vasen	
	2079707D	Sivupalkki 15 ala oikea	

No	Tuotekoodi	Nimi	Kuva
4	2079707G	Kaide 15	
5	2079716	Nostokoukku	
6	2079719	Kaidepidike	
7	2079718	Lukkorauta	
8	2079717	Laattakiinnike	
9	2079712	Välituki 1 m	



Tammet Oy  
Metallikutomonkatu 1  
10600 Tammisaari

[www.tammet.fi](http://www.tammet.fi)  
[info@tammet.fi](mailto:info@tammet.fi)  
+358 201 450 201

